



5-year warranty



Type overview

Type	DN
G220B-K	20

Technical data

Functional data	Valve Size	0.75" [20]
	Fluid	chilled or hot water, up to 60% glycol, steam
	Fluid Temp Range (water)	20...280°F [-7...138°C]
	Fluid Temp Range (steam)	32...280°F [0...138°C]
	Body Pressure Rating	ANSI Class 250, up to 400 psi below 150°F
	Flow characteristic	modified equal percentage
	Servicing	repack kits available
	Rangeability Sv	100:1
	Max Differential Pressure (Steam)	20 psi [103 kPa]
	Flow Pattern	2-way
	Leakage rate	ANSI Class VI
	Controllable flow range	stem up - open A – AB
	Cv	7.5
	Maximum Inlet Pressure (Steam)	35 psi [241 kPa]
	ANSI Class	250
	Body pressure rating note	up to 400 psi below 150°F
Materials	Valve body	Bronze
	Valve plug	brass
	Stem	stainless steel
	Stem seal	EPDM O-ring
	Seat	Bronze
	Pipe connection	NPT female ends
Suitable actuators	Non-Spring	LVB(X)
	Electronic fail-safe	LVKB(X)

Safety notes



- **WARNING:** This product can expose you to lead which is known to the State of California to cause cancer and reproductive harm. For more information go to www.p65warnings.ca.gov
- The valve has been designed for use in stationary heating, ventilation and air-conditioning systems and must not be used outside the specified field of application, especially in aircraft or in any other airborne means of transport.
- Only authorised specialists may carry out installation. All applicable legal or institutional installation regulations must be complied during installation.
- The valve does not contain any parts that can be replaced or repaired by the user.
- When determining the flow rate characteristic of controlled devices, the recognised directives must be observed.

Installation notes

Flow direction The direction of flow, specified by an arrow on the housing, is to be complied with, since otherwise the valve could become damaged.

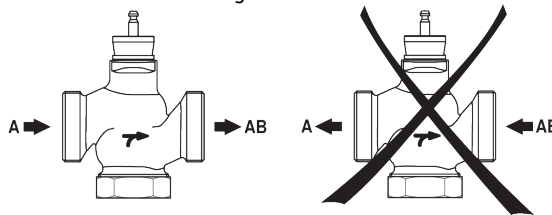

Dimensions

Dimensional drawings

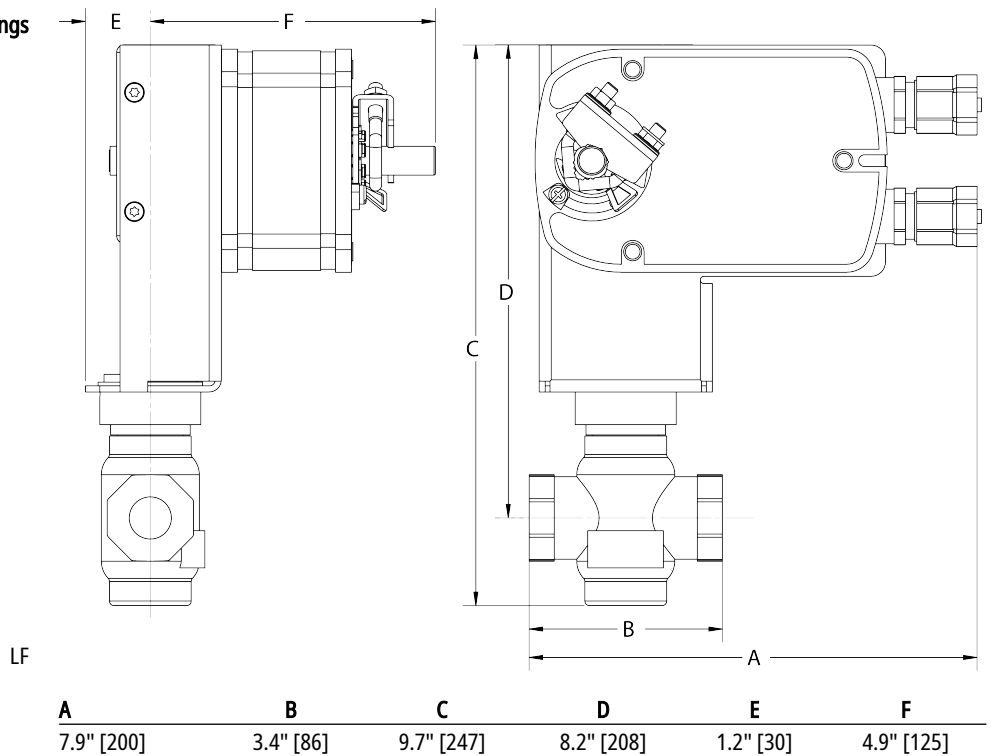

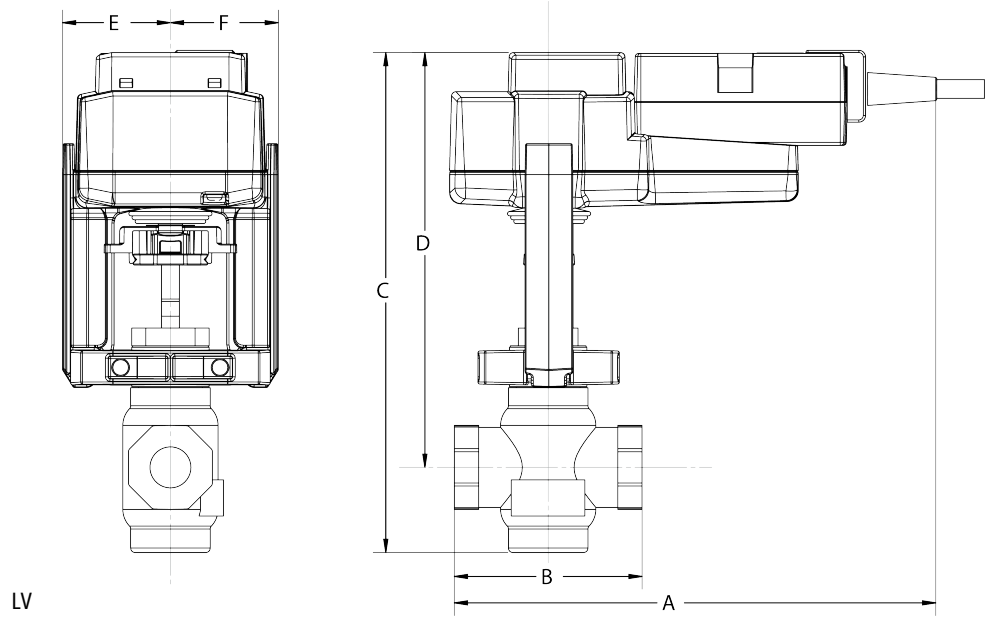

LV

A	B	C	D	E	F
8.6" [218]	3.4" [86]	8.9" [226]	7.4" [188]	1.9" [48]	1.9" [48]

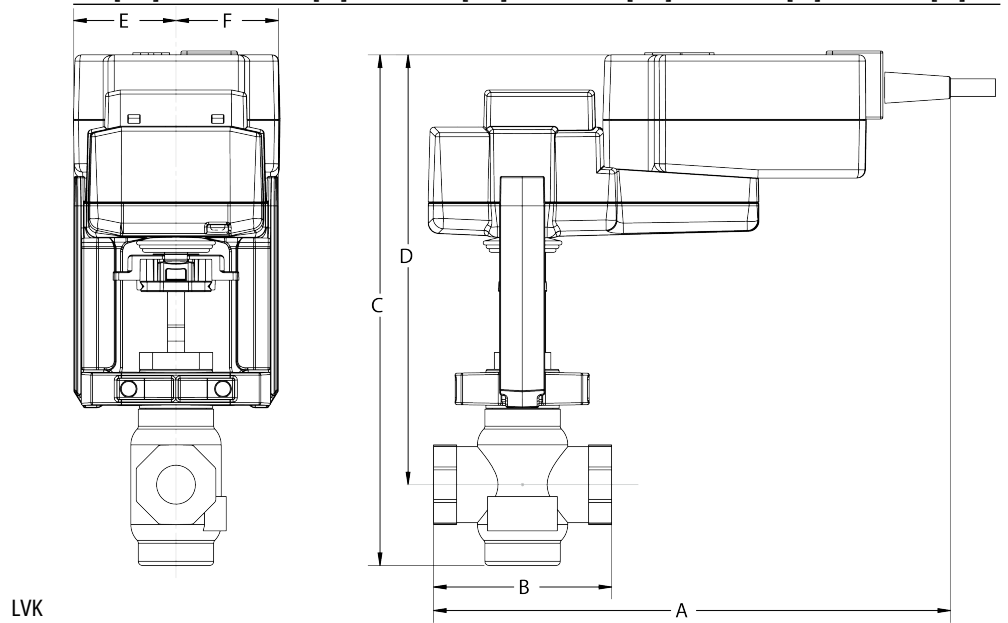

LVK

A	B	C	D	E	F
9.7" [246]	3.4" [86]	9.6" [244]	8.1" [206]	1.9" [48]	1.9" [48]

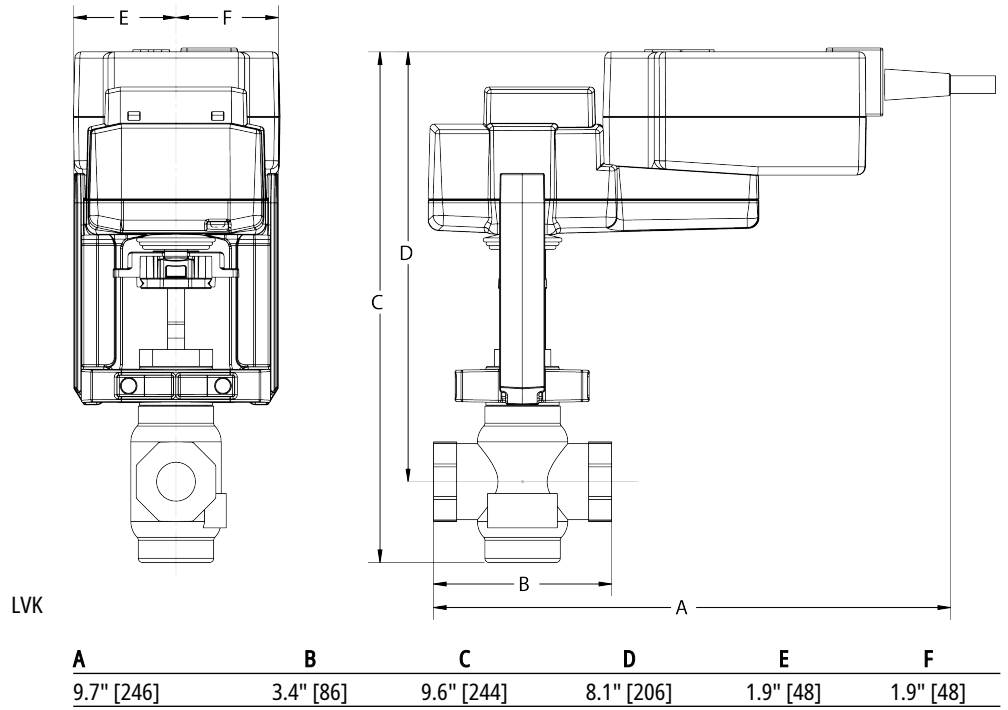

LVK



5-year warranty



Technical data

Electrical data	Nominal voltage	AC/DC 24 V
	Nominal voltage frequency	50/60 Hz
	Power consumption in operation	1 W
	Power consumption in rest position	0.5 W
	Transformer sizing	1 VA (class 2 power source)
	Electrical Connection	18 GA plenum cable, 3 ft [1 m], with 1/2" conduit connector, degree of protection NEMA 2 / IP54
	Overload Protection	electronic throughout full stroke
	Electrical Protection	actuators are double insulated
Functional data	Actuating force motor	115 lbf [500 N]
	Input Impedance	100 k Ω (0.1 mA), 500 Ω , 1000 Ω (on/off)
	Position feedback U note	No Feedback
	Direction of motion motor	selectable with switch 0/1
	Manual override	4 mm hex crank (shipped w/actuator)
	Stroke	0.75" [19 mm]
	Running Time (Motor)	default 90 s, variable 90 or 150 s
	Running time motor variable	90 or 150 s
	Noise level, motor	55 dB(A)
	Position indication	Mechanically, with pointer
Safety data	Degree of protection IEC/EN	IP54
	Degree of protection NEMA/UL	NEMA 2 UL Enclosure Type 2
	Agency Listing	cULus acc. to UL60730-1A/-2-14, CAN/CSA E60730-1:02, CE acc. to 2014/30/EU and 2014/35/EU
	Quality Standard	ISO 9001
	Ambient temperature	-22...122°F [-30...50°C]
	Storage temperature	-40...176°F [-40...80°C]
	Ambient humidity	max. 95% r.H., non-condensing
	Servicing	maintenance-free
Weight	Weight	2.87 lb [1.3 kg]
Materials	Housing material	Die cast aluminium and plastic casing

Safety notes



- PVC W/Shld for GV w/UGLK (GM)
- Battery Back Up System for SY(7~10)-110
- 120 to 24 VAC, 40 VA transformer.
- 50% voltage divider kit (resistors with wires).
- PC Tool computer programming interface, serial port.

Electrical installation

✂ INSTALLATION NOTES

2 Actuators may be connected in parallel. Power consumption and input impedance must be observed.

3 Actuators may also be powered by 24 VDC.

18 Actuators with plenum cable do not have numbers; use color codes instead.

◆ Meets cULus requirements without the need of an electrical ground connection.

⚠ Warning! Live Electrical Components!

During installation, testing, servicing and troubleshooting of this product, it may be necessary to work with live electrical components. Have a qualified licensed electrician or other individual who has been properly trained in handling live electrical components perform these tasks. Failure to follow all electrical safety precautions when exposed to live electrical components could result in death or serious injury.

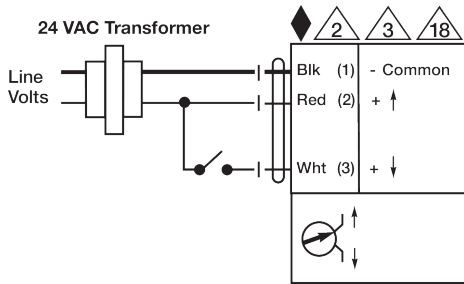

On/Off

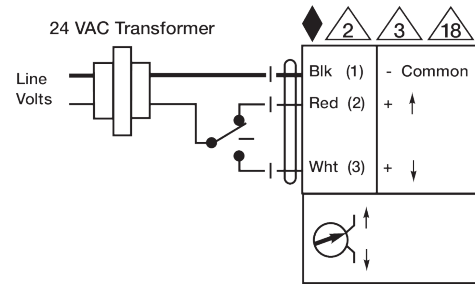

Floating Point

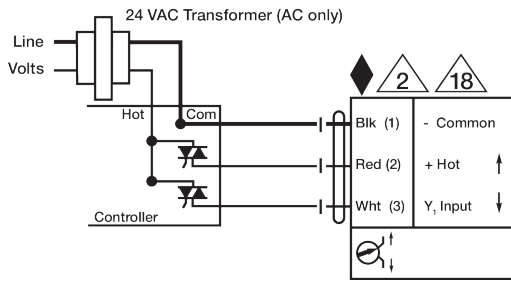

Triac Source

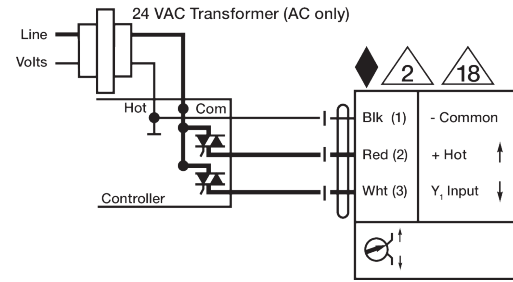

Triac Sink